

# Quality made simple.



## **ZEISS Axiovert 5**

Your Smart Microscope for Cell Culture and Research.

[zeiss.com/axiovert](https://zeiss.com/axiovert)



Seeing beyond

# Your Smart Microscope for Cell Culture and Research.

- › In Brief
- › The Advantages
- › The Applications
- › The System
- › Technology and Details
- › Service

So you're looking for a robust microscope for your lab. One with the fastest time to picture and with excellent image quality. And—why not?—one that's really satisfying to work with during those long hours in the lab.

Now that's smart, and so is the ZEISS Axiovert 5, your smart inverted cell culture microscope. All you need to do is focus on your samples and workflow. Then simply push Snap to get crisp images for documentation. Use all standard contrasting techniques in transmitted light and combine them with multichannel fluorescence to investigate your cell or tissue cultures. And—saving the best for last—when space is tight, you can even use this smart microscope as a standalone and save your images on a USB stick. No extra computer or software needed.

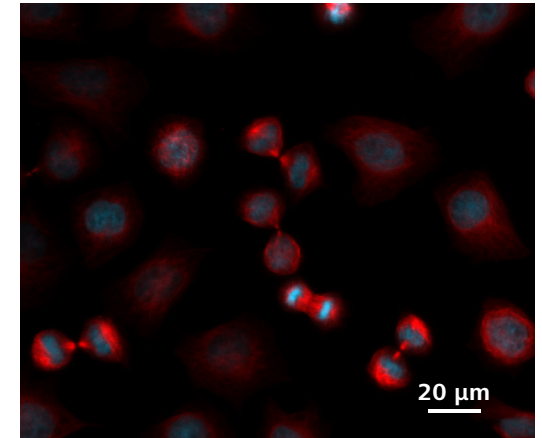

*HeLa Kyoto cells, objective: LD Plan-Neofluar 63x. 2-channels fluorescence image: nuclei in blue, tubulin in red.*

# Simpler. More Intelligent. More Integrated.

- › In Brief
- › **The Advantages**
- › The Applications
- › The System
- › Technology and Details
- › Service

## Be smart.

### Use Smart Microscopy.

ZEISS Axiovert 5 is very smart indeed, delivering excellent results with fast time to image. Simply focus your sample and press a single button to save a crisp image of your cell or tissue culture. For transmitted light and multichannel fluorescence images, this smart microscope automatically adjusts the settings and parameters for you. The overlaid multichannel fluorescence image includes the scaling information, which is automatically saved.

## Go for a Future-Proof Live Cell Microscope.

From routine cell culture to research, Axiovert 5 fits seamlessly into your lab and workflow. Various contrasting techniques—such as DIC, iHMC and phase contrast as well as multichannel fluorescence—open up a huge diversity of applications. Combine it with a compatible stage top incubator and you can use Axiovert 5 even for long-term live cell imaging. Should your work requirements change, Axiovert 5 will adapt, too. With upgradeable hardware and software, this smart microscope will always remain your reliable lab partner.

## Relax.

### And enjoy your daily routine.

Axiovert 5 lets you stop counting the hours. Its ergonomic user concept and clever features support you throughout your daily work. Just keep your eye on your sample: you can access all the main controls with one hand, including the snap button, stage drive, focus adjustment and brightness control. The light manager provides uniform brightness at all magnifications, eliminating manual adjustments to the lamp intensity when you're changing objectives. To increase the speed and reliability of your cell procedures even more, opt for the AI Cell Confluency and AI Cell Counting modules in Labscope. You'll get instant, reproducible information on your cells.

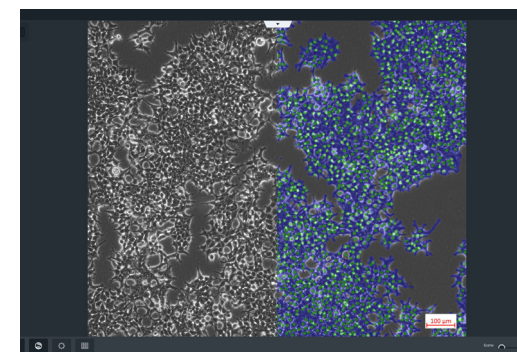

## Expand Your Possibilities

- › In Brief
- › **The Advantages**
- › The Applications
- › The System
- › Technology and Details
- › Service

### **Acquire Multichannel Fluorescence Images.**

Axiovert 5 is equipped with a six-position reflector turret that makes plenty of room for your experiments with different fluorophores and fluorescent markers.

Likewise, the six-position nosepiece gives you up to six objectives to handle everything you need in any situation. With the light-shield blocking ambient light, you can use Axiovert 5 anywhere in the lab — even in broad daylight.

### **Capture up to Five Different Channels with Just One Click.**

Combine Axiovert 5 with the high-performance LED light source Colibri 3 and any ZEISS microscope camera will give you the perfect setup for easy multichannel fluorescence documentation. Switch effortlessly between the channels for UV, blue, green and red excitation or transmitted light: just select the relevant channels and press Snap.

The system will then take over and automatically control the light, adjust the exposure time, acquire the image, switch the channel and start again. That's it: you get your overlaid multichannel fluorescence image, including a scale bar — even without a PC. Conditions are perfect for low fluorescence intensities such as transfection checks, and also for conclusive images of cellular structures for your next publication.

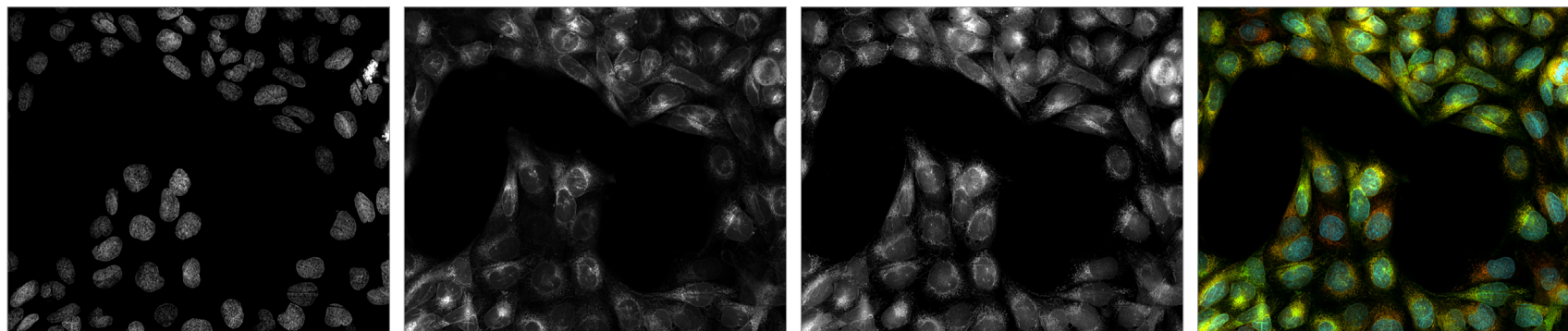

*U2OS cell, stained with NucBlue, CellMask green, MitoTracker Red and multichannel overlay; Objective: Plan-Apochromat 20x/0.8*



# Expand Your Possibilities

- › In Brief
- › **The Advantages**
- › The Applications
- › The System
- › Technology and Details
- › Service

## Boost your Efficiency with Smart Microscopy

Efficiency and quality are key in your lab, but it can take a lot of time to acquire multichannel fluorescence images. You know the drill: place the sample and focus on your region of interest, then switch to the computer, select the channel and adjust settings, then acquire an image, insert a scale bar, switch back to the microscope ... and on and on. Especially with manual microscopes this procedure can be cumbersome. Imagine, there were an easy and effortless way to acquire up to four fluorescence channels and one transmitted light channel .

With Axiovert 5, you can automate your workflow and stay focused on your sample at all times — that’s smart microscopy at work. Just press the Snap button on the microscope and you're done. The microscope automatically determines the ideal settings per channel. You get an overlaid multichannel fluorescence image with all relevant image data stored automatically in your metadata. This procedure integrates perfectly with your established microscopy workflow and boosts your efficiency tremendously.

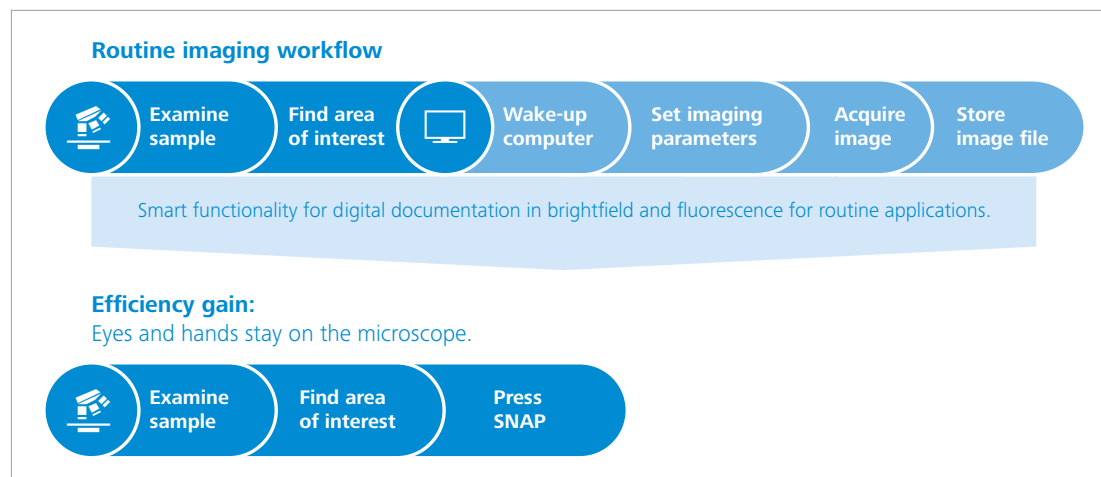

# Expand Your Possibilities

- › In Brief
- › **The Advantages**
- › The Applications
- › The System
- › Technology and Details
- › Service

## **This is Smart Microscopy.**

Axiocvert 5 comes with a Smart Control Box, incorporating all interfaces directly at the stand. You can use Axiocvert 5 in standalone mode without any additional PC as it is intelligently integrated into the system. Control the microscope via On Screen Display (OSD) or use Labscope, the imaging app from ZEISS. Choose from a variety of ZEISS Axiocam microscope cameras to take full advantage of the smart microscopy concept. Camera settings, light control, and image enhancement functions are done automatically. All you have to do is to focus on your sample.

Without any additional imaging software or even a computer, you can:

- snap images and record videos directly from your stand.
- use a mouse or optionally a keyboard to control your system via the OSD (On Screen Display).
- save settings.
- store images along with all metadata of the microscope and camera such as scaling information.
- connect to Wi-Fi or a network, independently from the ZEISS Axiocam you're using.



# Expand Your Possibilities

- › In Brief
- › **The Advantages**
- › The Applications
- › The System
- › Technology and Details
- › Service

## Adapt ZEISS Axiovert 5 to Your Lab Space and Task.

If lab space is limited, just get rid of the PC and all that additional software: use Axiovert 5 in standalone mode and control the microscope via the OSD menu.

For your daily checks, opt for Labscope, the imaging app from ZEISS. It's free, and all you need to do is download it on your iPad or Windows PC and you're ready for image acquisition. For more sophisticated experiments we recommend ZEN imaging software.

### Stand-alone for Basic Routine Imaging

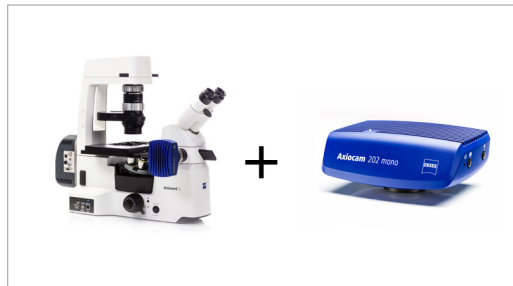

Digital documentation works even without a computer. Use an AxioCam microscope camera with ZEISS Axiovert 5 and control the system via the On Screen Display (OSD).

### ZEISS Labscope for Advanced Routine Imaging



Operating ZEISS Axiovert 5 with ZEISS Labscope imaging software is ideal for connected microscopy and standard multichannel fluorescence imaging.

### ZEISS ZEN for Research Applications

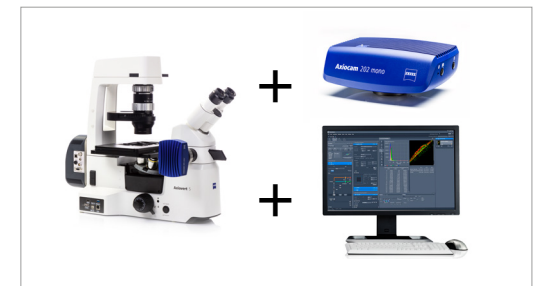

Use ZEN imaging software to perform advanced imaging tasks with ZEISS Axiovert 5.

# Expand Your Possibilities

- › In Brief
- › **The Advantages**
- › The Applications
- › The System
- › Technology and Details
- › Service

## Make Your Cell Experiments More Reproducible.

If you work with cell cultures such as COS-7, HeLa, LoVo or U2OS, then you probably know all about tasks like determining cell confluency and counting cells. These are your critical values for further decisions on cell proliferation, viability, adapting environmental conditions, harvesting cells, starting transfections and preparing experiments. And both cell confluency and counting must work independently of shape, size and type of cell. Doing this manually can be a time-consuming, labor-intensive process with results that are error-prone and subjective.

It's time to start making your experiments more reproducible, using pre-trained artificial intelligence to analyze the number of cells and the covered cell area automatically. The ZEISS Labscope modules AI Cell Confluency and AI Cell Counting fit perfectly into your workflow. Examine your cells as usual, then simply take a picture as you move from one position to another in your cell culture vessel. The images are analyzed automatically and you will receive an instant result, visually and quantitatively.

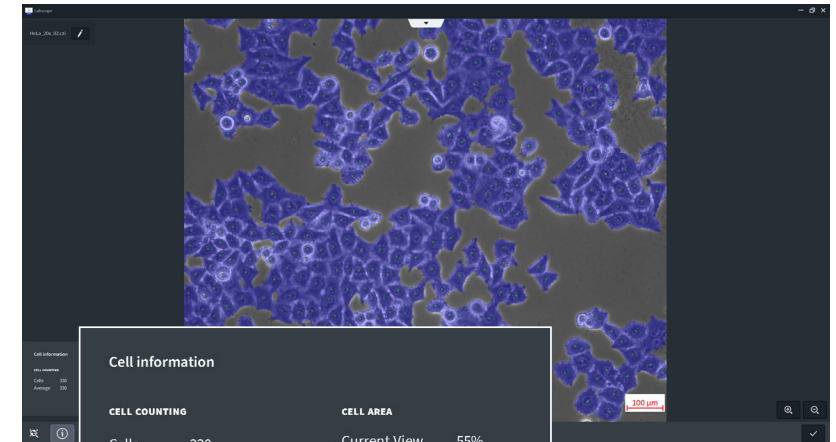
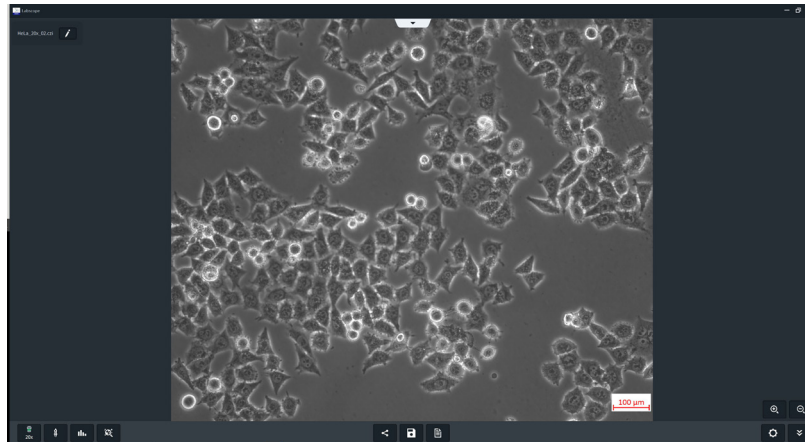

HeLa cell line, 20x objective; left: image in phase contrast; right: analyzed image with ZEISS Labscope modules AI Cell Confluency and AI Cell Counting



# Expand Your Possibilities

- › In Brief
- › **The Advantages**
- › The Applications
- › The System
- › Technology and Details
- › Service

## Take Advantage of All Standard Contrasting Techniques — In One Microscope.

Transmitted light observation is the basis of every cell culture and thus the starting point of every experiment. With Axiovert 5 and its bundle of contrasting techniques, you quite simply get all of the information from your cells. Choose from all standard contrasting techniques, including DIC, to investigate your cell cultures. Axiovert 5 is ideal for every cell line, every tissue and every user.

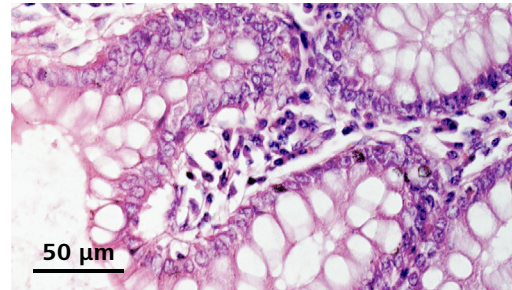

*Intestine in transmitted light, brightfield. HE staining*

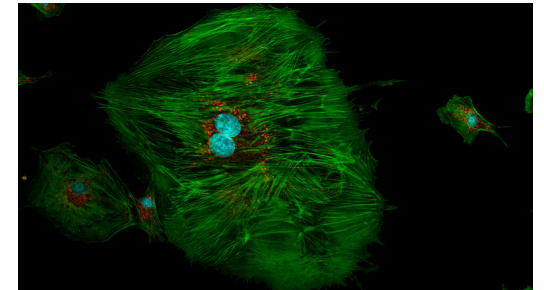

*Multichannel fluorescence image of bovine pulmonary artery cells*

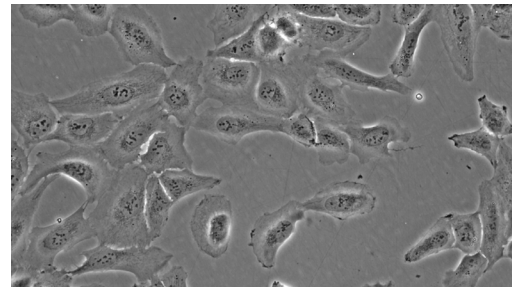

*U2OS cells in transmitted light, phase contrast.*

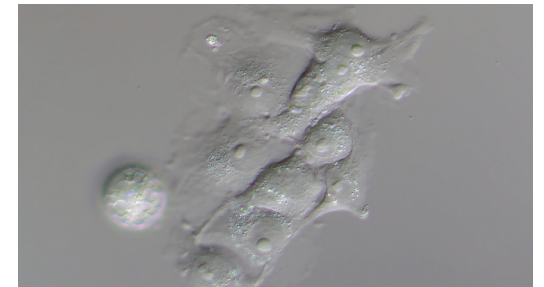

*Cells in transmitted light, PlasDIC*

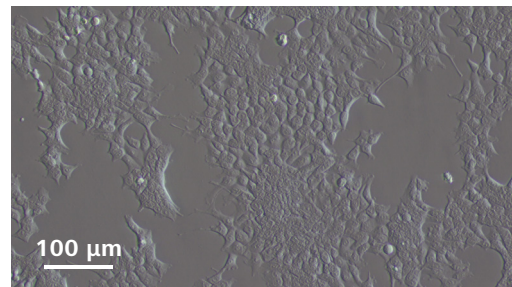

*Cos 7 in improved Hofman Modulation Contrast (iHMC)*

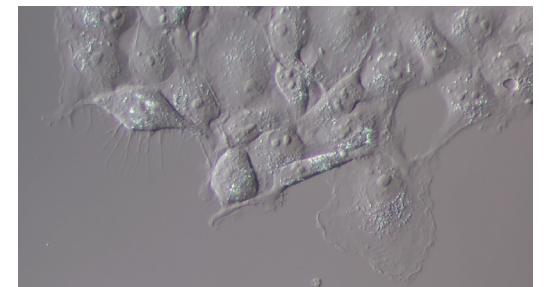

*Cells in transmitted light, DIC*

## Expand Your Possibilities

- › In Brief
- › **The Advantages**
- › The Applications
- › The System
- › Technology and Details
- › Service

### **Acquire Virtual Slides Manually— with Ease.**

If from time to time you need to scan histological samples in your lab, then opt for Labscope's Fast Panorama module and turn your Axiovert 5 into a whole slide imaging system. By manually moving the stage of your microscope, images of the sample will be stitched together automatically into a panoramic picture. This is the ideal solution if you have to scan whole slide images (WSI) once in a while.

Whether you want to digitize a complete sample or only parts of it in high resolution, the Labscope module Fast Panorama provides an easy solution. Documentation or archiving of rare and interesting samples is now possible even on a manual microscope. You can also use this functionality to collaborate with partners and share your data easily. Digitizing whole slide images and using these virtual slides prove to be very useful for educational purposes.

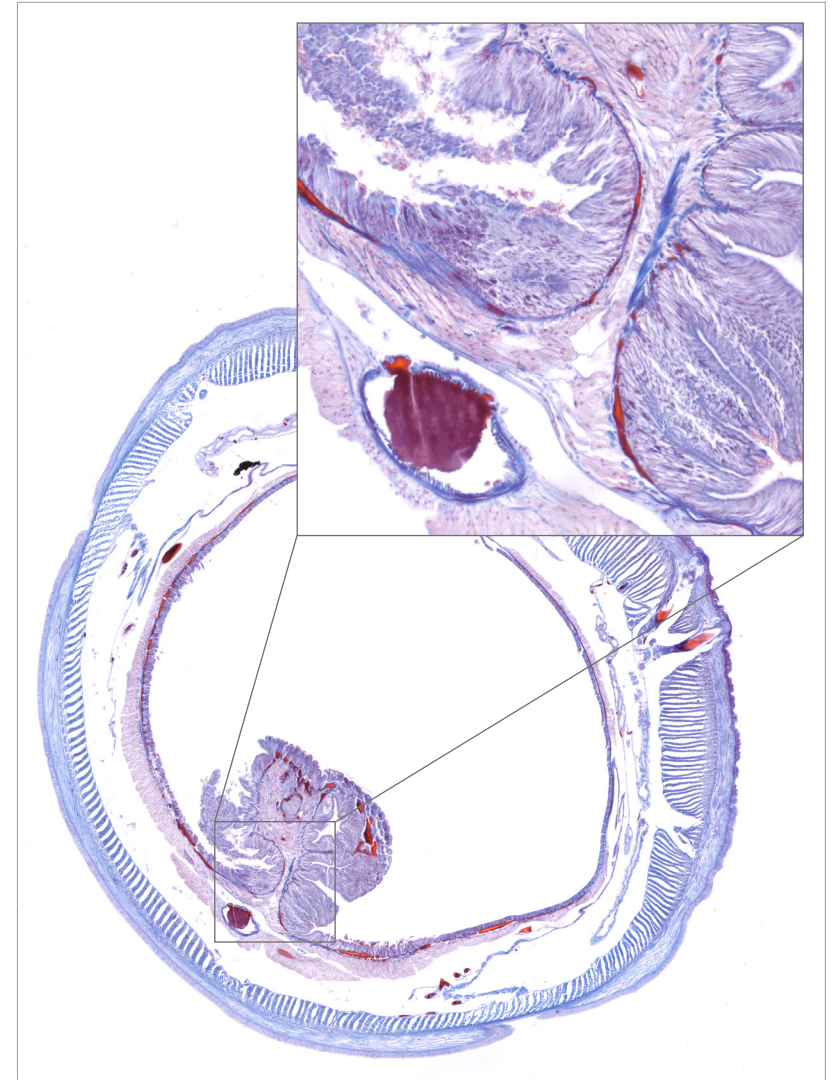

*Earthworm in brightfield, acquired with ZEISS Labscope Fast Panorama*

# Expand Your Possibilities

- › In Brief
- › **The Advantages**
- › The Applications
- › The System
- › Technology and Details
- › Service



The Smart Control Box lets you work with ZEISS Axiocam microscope cameras in stand-alone operation or with ZEISS Labscope.

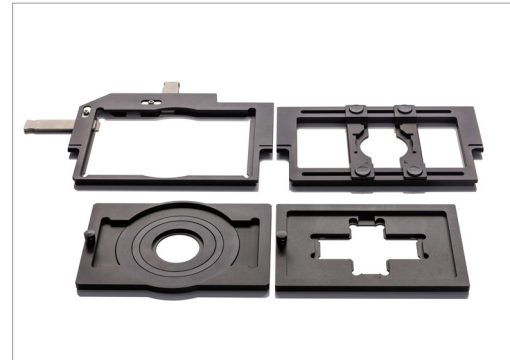

Various stage inserts let you use different cell culture vessels.

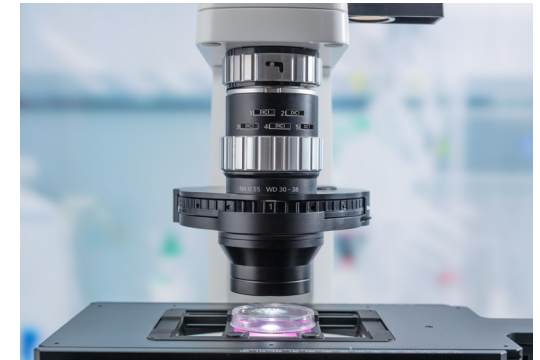

The LD condenser 0.55 offers a free working distance of up to 38 mm.



The encoded 6-fold reflection turret and 6-fold nosepiece turret offer flexibility.



Attach the light shield to block ambient light from the sample.



The Aqua Stop II protects the objectives and other optical components inside the microscope from liquids.

# Expand Your Possibilities

- › In Brief
- › **The Advantages**
- › The Applications
- › The System
- › Technology and Details
- › Service



*Use the optional adapter for expansion to handle large cell stacks or cell factories up to an height of 220 mm.*



*The recess at the front of the microscope is optimal to carry the microscope safely and to place it on wet lab benches.*



*The lights at the Colibri 3 LED illumination indicate which channel you're using.*



# ZEISS Axiovert 5 at Work

- › In Brief
- › The Advantages
- › **The Applications**
- › The System
- › Technology and Details
- › Service

## Daily Cell Culture

Cell cultures are crucial for nearly every experiment in cell biology. You need to monitor and maintain your cell culture regularly. When the number has grown to a certain level, you need to count them. Cells can then be seeded for experiments or need to get passaged or splitted. With Axiovert 5 in combination with Labscope AI Cell counting and Cell confluency you can handle this everyday task with ease. The data is reproducible and comparable.

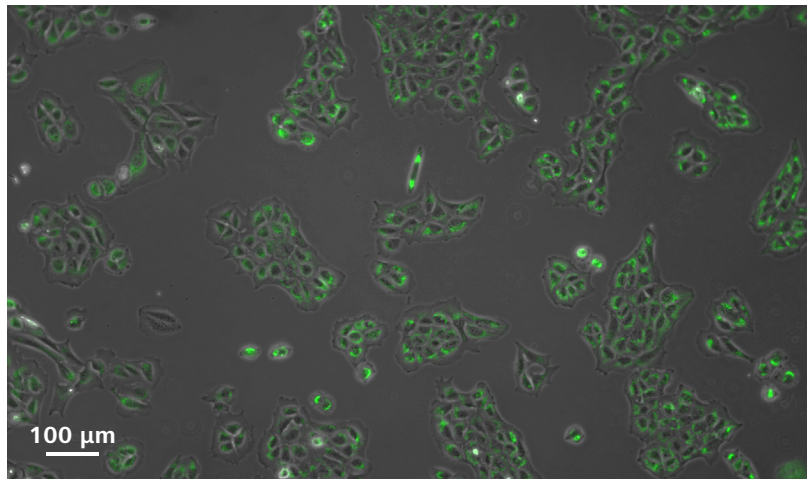

U2OS cell line. Phase contrast image merged with fluorescence channel to check the transfection efficiency.

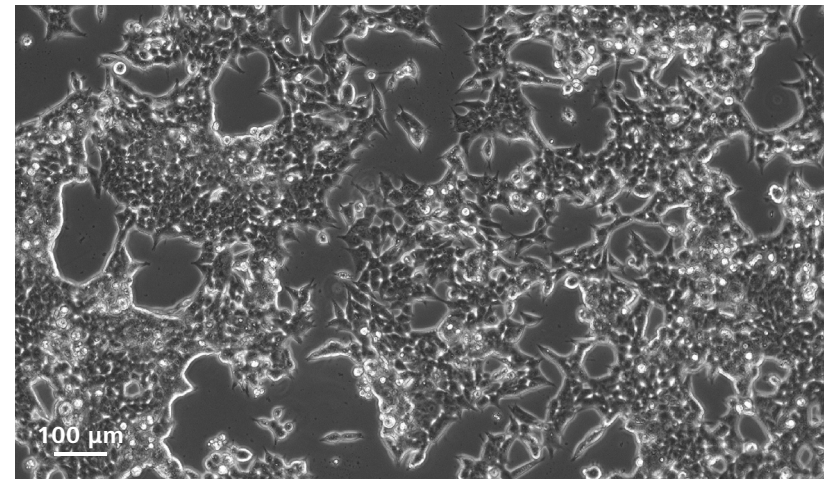

HEK cells in culture imaged using phase contrast.

# ZEISS Axiovert 5 at Work

- › In Brief
- › The Advantages
- › **The Applications**
- › The System
- › Technology and Details
- › Service

## Cell Seeding

You need reproducible results and need to check whether the number of cells has increased in culture. Manually done, this is can be a rather time-consuming, labor-intensive process with error-prone, subjective results. With the ZEISS Labscope modules AI Cell Confluency and AI Cell Counting you get an efficient and reliable way to quickly monitor, count and analyze a cell population. All it takes is the push of a button.

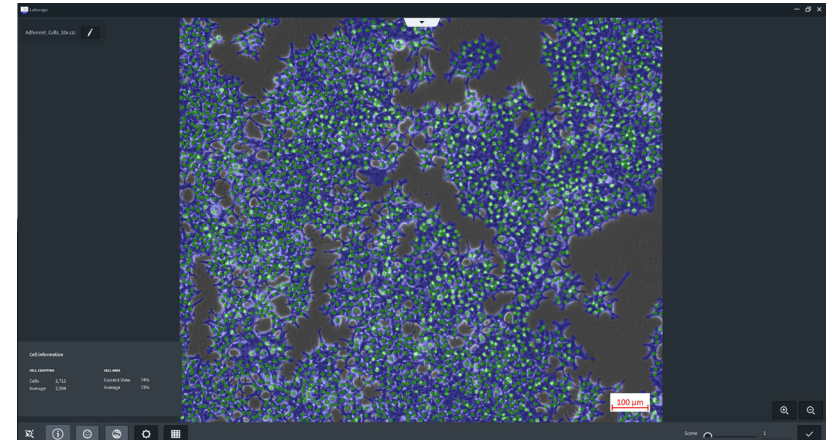

*HeLa cells in phase contrast, imaged and analyzed using ZEISS Labscope*



*LLC-PK1 in phase contrast*

# ZEISS Axiovert 5 at Work

- › In Brief
- › The Advantages
- › **The Applications**
- › The System
- › Technology and Details
- › Service

## Immunohistochemistry – Fluorescently labeled cellular structures and proteins

Fluorescently labeled cellular structures by GFP or immunohistochemistry are an important part of cell biology research for many years. With Axiovert 5 you can visualize and image different structures and their behavior in relation to each other in separate channels. The 6x reflector turret provides plenty of room to address a large variety of fluorophores. You can easily perform experiments from transfection efficiency examinations to more complex protein interaction analyses.

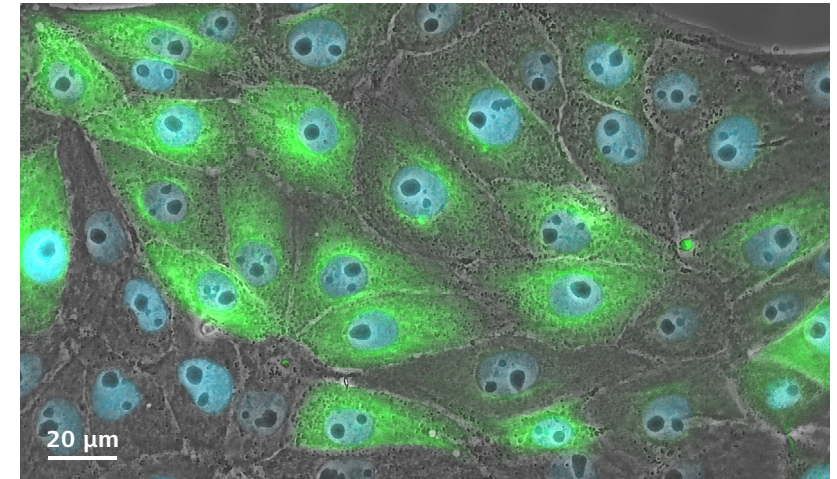

*LLC-PK1 cells imaged with phase and fluorescence contrast for protein expression analysis.*

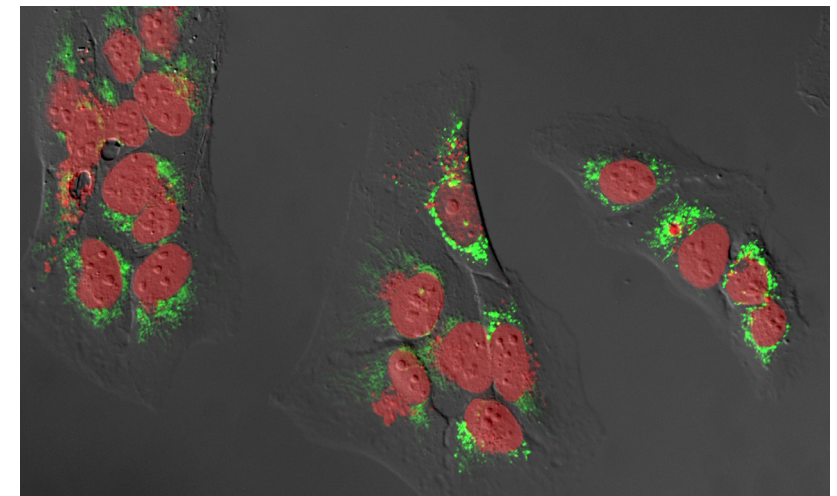

*U2OS cells transfected with MitoTracker green and NucRed 647, overlaid with DIC.*



# ZEISS Axiovert 5 at Work

- › In Brief
- › The Advantages
- › **The Applications**
- › The System
- › Technology and Details
- › Service

## Tissue Sections

Stained tissue sections are essential samples in biomedicine. You need to document and analyze them in large numbers. Thanks to its ergonomic design, Axiovert 5 allows long work at the microscope without fatigue. You can access all the main controls with one hand. With Labscope you can measure and annotate structures in the live image or the acquired image.



Tissue section in brightfield



# ZEISS Axiovert 5 at Work

- › In Brief
- › The Advantages
- › **The Applications**
- › The System
- › Technology and Details
- › Service

## **Perform your procedures with high confidence.**

Visualizing fine details of oocytes and embryos is particularly important in artificial reproductive technologies (ART) but also in medical and veterinary research when micromanipulation, e.g. for CRISPR injection, comes into play. Axiovert 5 is your robust and stable microscope that combines all important contrasting techniques in one configuration.

- With iHMC you see the nucleus shape and nucleoli clearly.
- Structures such as the zona pellucida of oocytes are brought out particularly well by the PlasDIC contrasting technique. The strong and brilliant relief effect enables you to judge precisely where to inject.
- DIC delivers brilliant images to assess the shape and vacuole count of sperm cells.

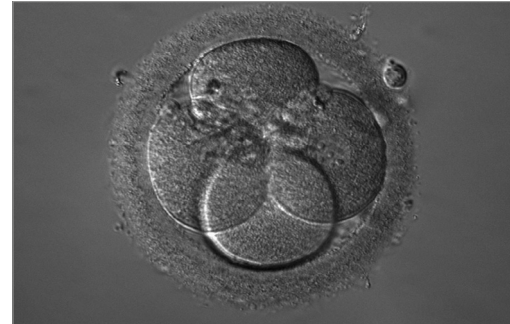

*Embryo: Nucleus with nucleoli visible in right cell, iHMC*

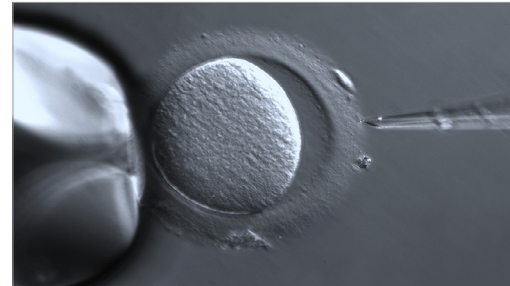

*ICSI: Visualization of oocyte with Zona pellucida, PlasDIC*

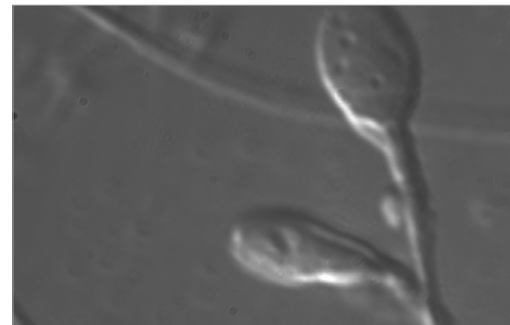

*IMSI: Visualization of vacuoles in sperm cells, DIC*

# Your Flexible Choice of Components

- › In Brief
- › The Advantages
- › The Applications
- › **The System**
- › Technology and Details
- › Service

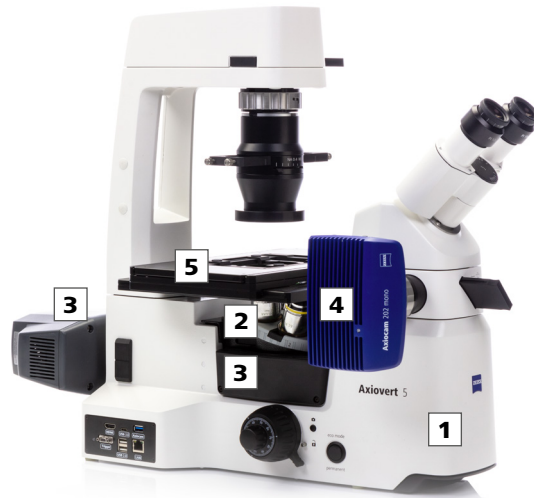

## 1 Microscope

- ZEISS Axiovert 5 TL (transmitted light)
- ZEISS Axiovert 5 TL SCB (transmitted light, Smart Control Box)
- ZEISS Axiovert 5 TL FL SCB (transmitted/fluorescence light, Smart Control Box)

## 2 Typical Objectives

- LD A-Plan
- LD Plan-Neofluar Corr

## 3 Illumination

- TL: LED 10 W
- FL: Colibri 3

## 4 Recommended Cameras

- AxioCam 202 mono
- AxioCam 208 color
- AxioCam 305 color

## 5 Accessories

- Light shield, stages, mounting frames, Aqua Stop II, condensors
- Filter sets, contrast modules

## Recommended Software

- ZEISS Labscope

# System Overview

- › In Brief
- › The Advantages
- › The Applications
- › **The System**
- › Technology and Details
- › Service

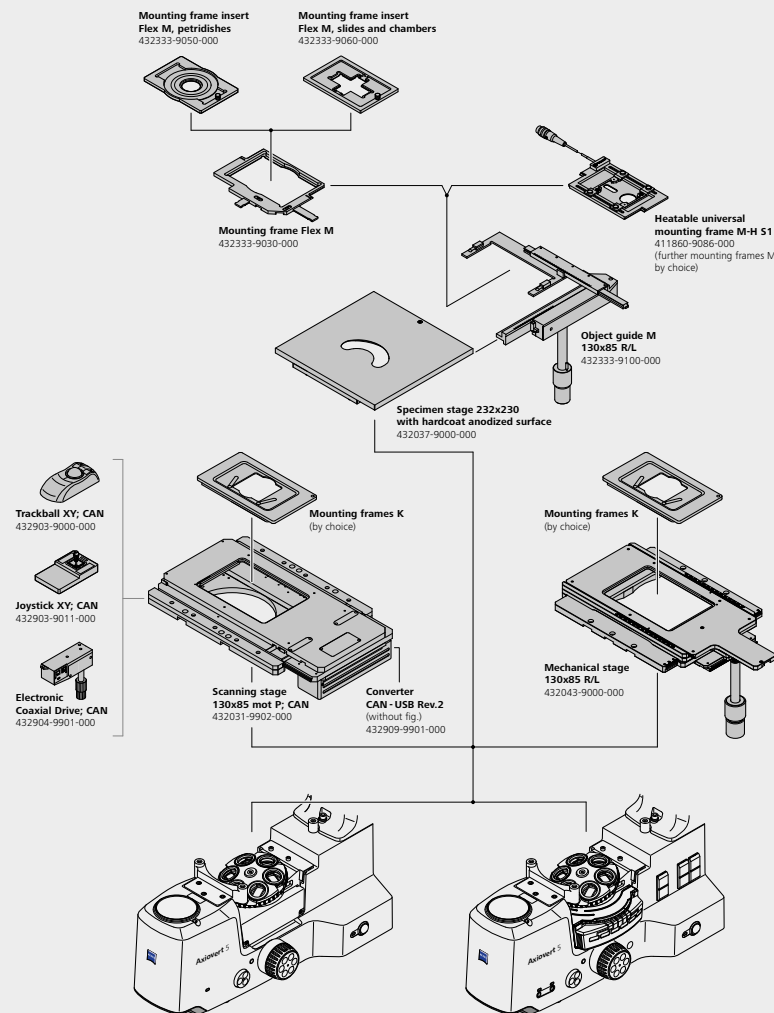
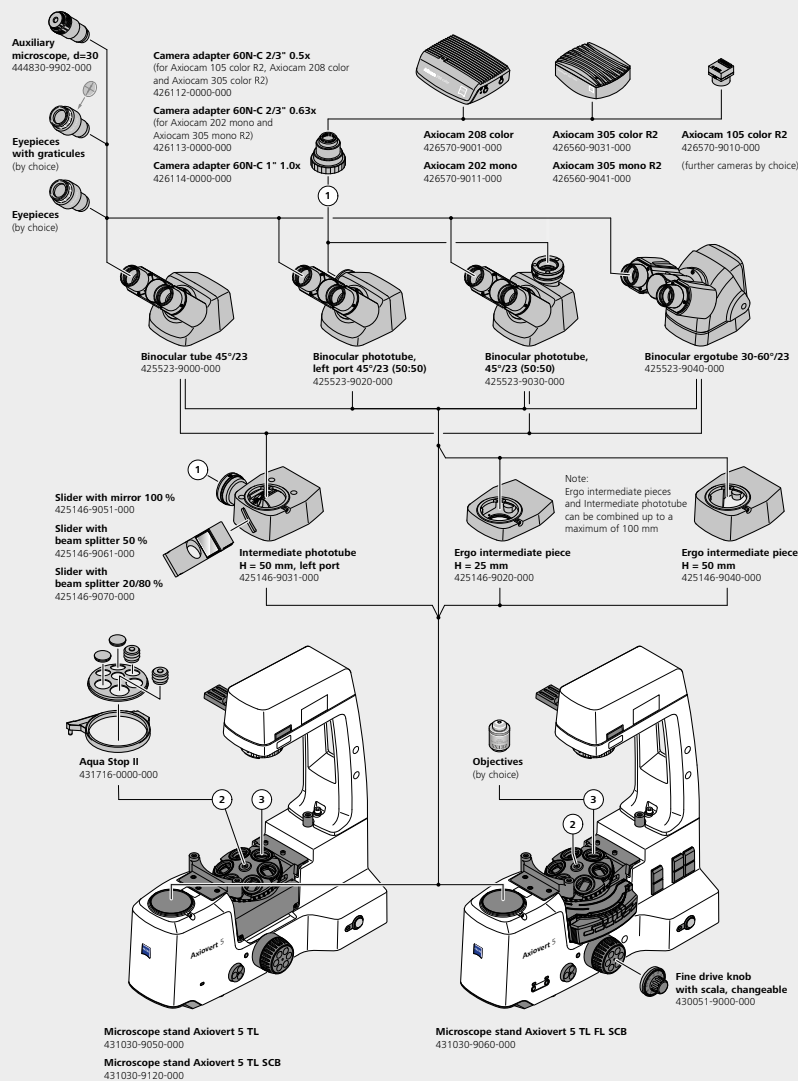

# System Overview

- › In Brief
- › The Advantages
- › The Applications
- › **The System**
- › Technology and Details
- › Service

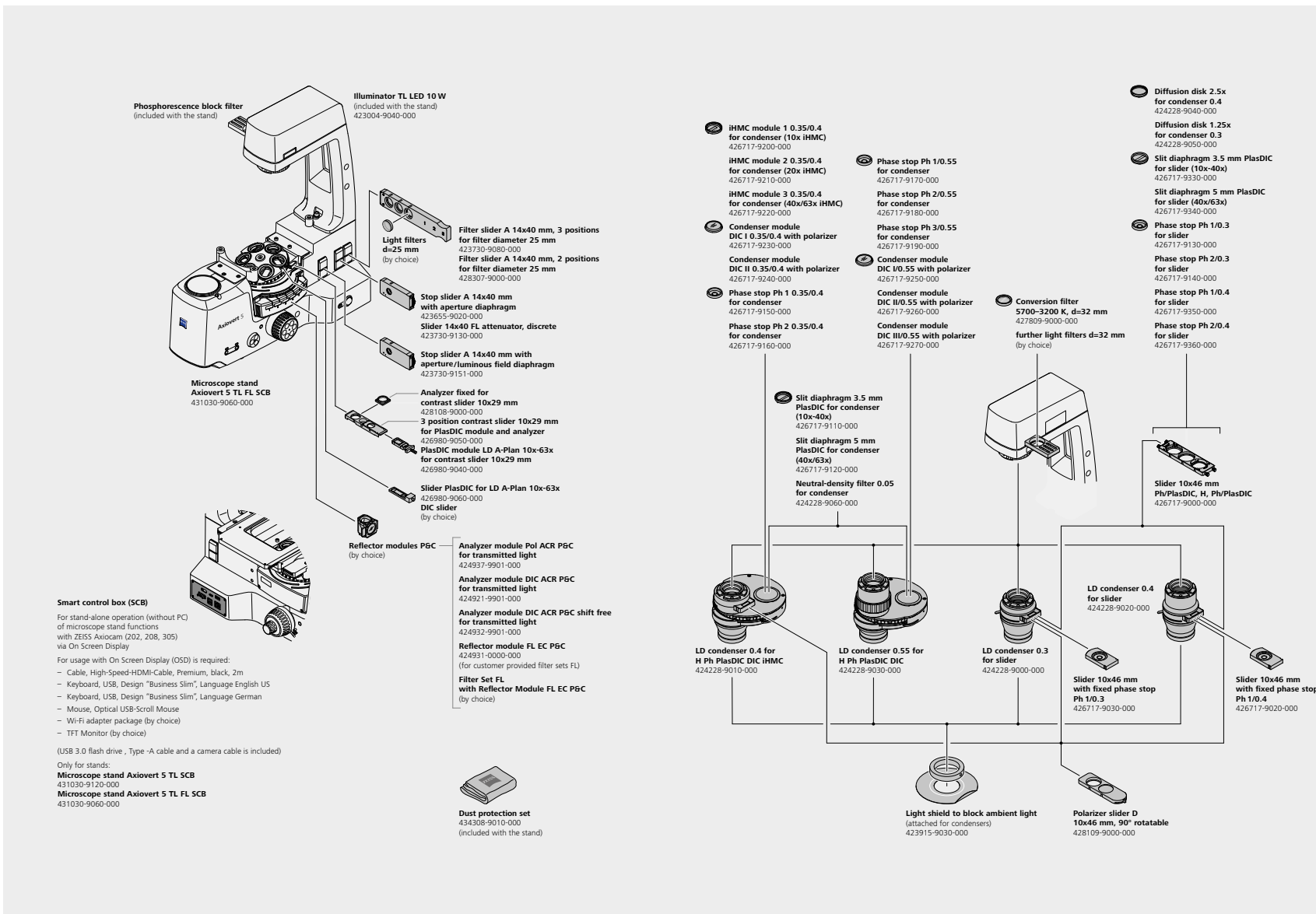



# System Overview

- › In Brief
- › The Advantages
- › The Applications
- › **The System**
- › Technology and Details
- › Service

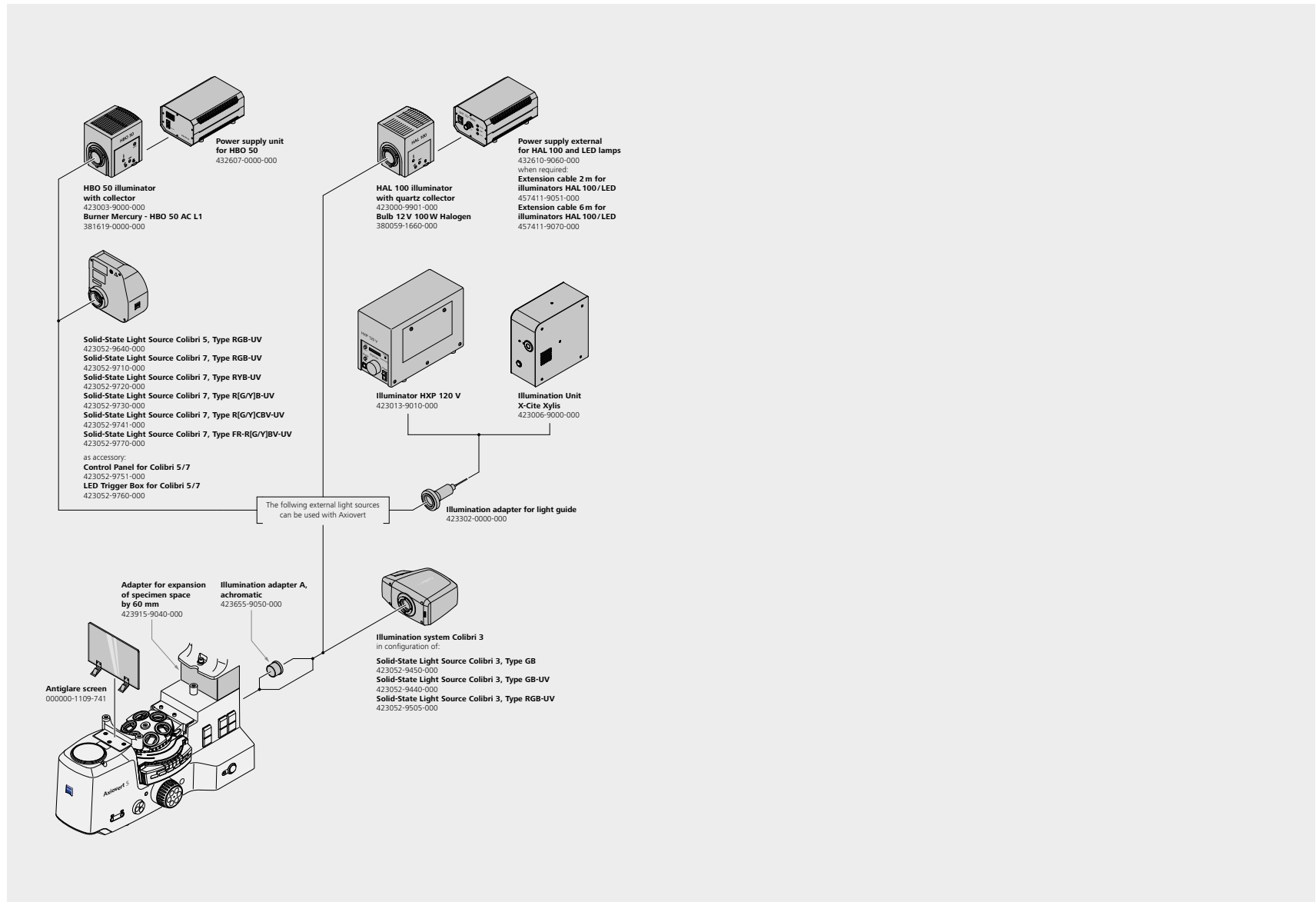

# Technical Specifications

- › In Brief
- › The Advantages
- › The Applications
- › The System
- › **Technology and Details**
- › Service

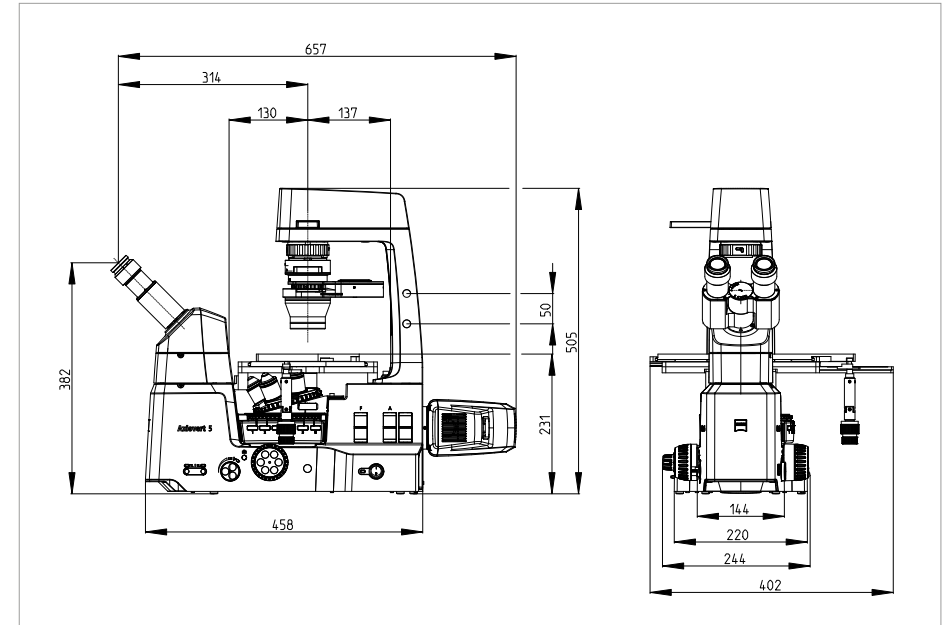
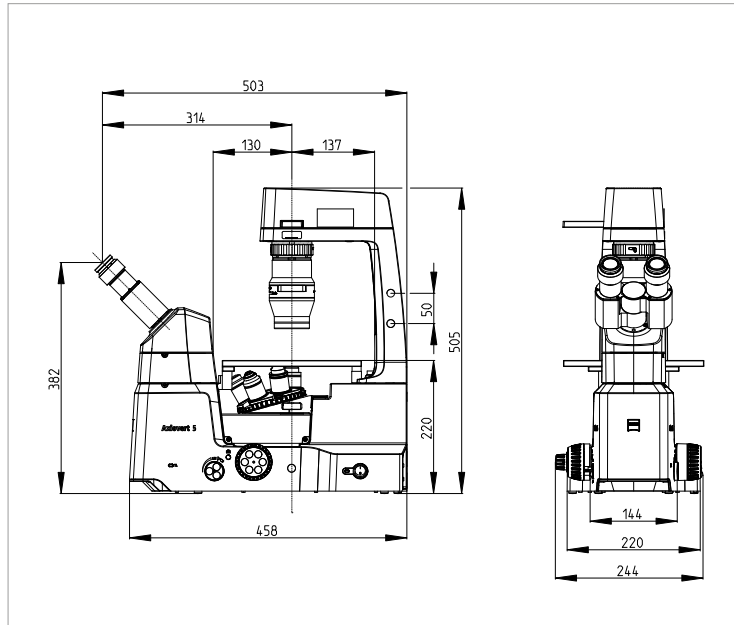

Weight and sizes	ZEISS Axiovert 5 TL	ZEISS Axiovert 5 TL SCB	ZEISS Axiovert 5 TL FL SCB
Dimensions	503 × 244 × 505 (L × W × H in mm)	503 × 244 × 505 (L × W × H in mm)	657 × 402 × 505 (L × W × H in mm)
Weight	11.0 kg	11.2 kg	12.2 kg

# Technical Specifications

- › In Brief
- › The Advantages
- › The Applications
- › The System
- › **Technology and Details**
- › Service

## Air conditioning and quality

Temperature range for operation with indicated performance (24 h per day, regardless of whether the microscope is in operation or switched off)	5 – 40 °C
Relative humidity	< 80 % at 40 °C
Atmospheric pressure / altitude	800 to 1060 hPa / ≤ 2000 m above sea level
Pollution degree	2

## Mains connection

Nominal AC voltage	L/N/PE 100 to 240 VAC ± 10 %
Nominal frequency	50/60 Hz
Max. current	1.4 A
Rating for microscope stand	24 VDC, 5 A
Protection Class	IP20 (IEC 60529)
Overvoltage category	II

## Usability of LED modules for Colibri 3 LED light source

Position	Slot 1	Slot 2	Slot 3	Slot 4
Wavelength (nm)	450–480	350–415	594–660	508–565
LED module 385 nm	○	●	○	○
LED module 470 nm	●	○	○	○
LED module 505 nm	○	○	○	●
LED module 565 nm	○	○	○	●
LED module 590 nm	○	○	●	○
LED module 625 nm	○	○	●	○

● usable    ○ not usable

# Technical Specifications

- › In Brief
- › The Advantages
- › The Applications
- › The System
- › **Technology and Details**
- › Service

Model	Axiovert 5 TL	Axiovert 5 TL SCB	Axiovert 5 TL/FL SCB
Optical system	Infinite, IC^2S		
Field of View	23 mm		
Nosepiece	6x nosepiece, encoded, all suitable for DIC slider		
Focus	Manual coarse/fine focus; 13 mm focus range with adjustable focus stop		
Objectives	Large choice of long distance and coverslip corrected objectives		
Objective magnification	1.25x–100x		
Contrast methods	BF, PH, PlasDIC, DIC, iHMC, POL		BF, PH, FL, PlasDIC, DIC, iHMC, POL
Transmitted light illumination	White 10 W LED, average lifetime > 60,000 h		
Phosphorescence block filter	Included in 2-position slider; prevents signal background in fluorescence imaging while allowing TL contrasts without changing slider position		
Light manager advanced	Yes (for TL)	Yes* (TL and FL)	
TL/RL indicator/button	TL indicator	TL and RL indicator/button on stand, to easily switch between TL and RL/FL	
Snap/Workflow button on stand	Ergonomically positioned on both sides of the stand; works with ZEISS AxioCam; allows to snap images, record videos, start workflows		
ECO mode	Activatable; saves power and goes to standby when not used for a period of time		
Reflector turret	6x reflector turret, encoded, for P&C** modules		
Fluorescence filter sets	Suitable for multi-bandpass and single-bandpass filter sets		
Fluorescence illumination	Colibri 3/5/7; HXP 120, X-cite Xylis, HBO 50, HAL 100		
Colibri 3	Available wavelengths (nm) 385, 470, 505, 565, 590, 625; average lifetime > 60.000 h (for 385 nm > 40.000 h); status indicator of active LED; control via microscope stand, OSD***, Labscope****, ZEN		
Light shield to block ambient light	Mountable to condenser via magnet; allows for improved fluorescence imaging in ambient light		
Condenser	LD-condensor 0.3 for slider, WD=72 mm; LD-condensor 0.4 for slider, WD=53 mm; LD-condensor 0.4 for H Ph PlasDIC DIC iHMC, WD=53 mm; LD-condensor 0.55 for H Ph PlasDIC DIC, WD=30–38 mm		
Tubes	As in AV.A1 brochure		
Intermediate phototube (eyepiece : camera)	Slider options: 0:100/100:0; 50:50/100:0; 20:80/100:0		
Ergo intermediate pieces	As in AV.A1 brochure		
Stages	As in AV.A1 brochure		
Smart Control Box for standalone operation (w/o PC)	Compatible with various AxioCam models; provides automatic camera functions, image enhancement functions and readout of encoded microscope functions; system control via OSD*** or Labscope; Wi-Fi compatible via USB Wi-Fi adapter or router		
60 mm expansion of specimen space	Optional		
Protection of objectives, nosepiece and the microscope from liquids	With Aqua Stop II		
Other accessories	Incubation equipment, mounting frames, heatable mounting frames, stage inserts, micromanipulation equipment		
System control via software	ZEN	OSD***, Labscope****, ZEN	OSD***, Labscope****, ZEN

\*settings take reflector position into account \*\*fluorescence filter cubes, Optovar, analyzer DIC, PlasDIC, and Pol \*\*\*On Screen Display \*\*\*\*with Labscope for Windows and iPad



## ZEISS Service – Your Partner at All Times

Your microscope system from ZEISS is one of your most important tools. For over 170 years, the ZEISS brand and our experience have stood for reliable equipment with a long life in the field of microscopy. You can count on superior service and support - before and after installation. Our skilled ZEISS service team makes sure that your microscope is always ready for use.

- › In Brief
- › The Advantages
- › The Applications
- › The System
- › Technology and Details
- › **Service**

### Procurement

- Lab Planning & Construction Site Management
- Site Inspection & Environmental Analysis
- GMP-Qualification IQ/OQ
- Installation & Handover
- IT Integration Support
- Startup Training

### Operation

- Predictive Service Remote Monitoring
- Inspection & Preventive Maintenance
  - Software Maintenance Agreements
    - Operation & Application Training
    - Expert Phone & Remote Support
  - Protect Service Agreements
    - Metrological Calibration
    - Instrument Relocation
      - Consumables
      - Repairs

### New Investment

- Decommissioning
- Trade In

### Retrofit

- Customized Engineering
- Upgrades & Modernization
- Customized Workflows via APEER



Please note: Availability of services depends on product line and location

>> [www.zeiss.com/microservice](http://www.zeiss.com/microservice)



**Carl Zeiss Microscopy GmbH**

07745 Jena, Germany  
microscopy@zeiss.com  
www.zeiss.com/axiovert

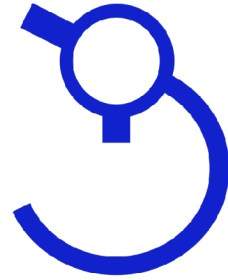

**Wenzel Mikroskoptechnik GmbH**

**seit 1996 Ihr kompetenter Fachhändler für**

**[ZEISS-Mikroskope](#)**

**Telefon [03641-828080](tel:03641-828080)**

**eMail [verkauf@mikroskoptechnik.de](mailto:verkauf@mikroskoptechnik.de)**

**im Netz [www.mikroskoptechnik.de](http://www.mikroskoptechnik.de)**